

Specifications

Conditions of Sale

STANDARD: The seller's standard conditions of sale set forth in Price Sheet 150 apply, except as modified by the "Special Warranty Provisions" and "Warranty Qualifications" sections on page 2.

SPECIAL TO THIS PRODUCT:

INCLUSIONS: The microprocessor-based IntelliCap 2000 Automatic Capacitor Control is specifically designed for the control of pole-mounted and pad-mounted switched capacitor banks, both in stand-alone and SCADA applications. Automatic control strategies are software selectable.

The IntelliCap 2000 Automatic Capacitor Control can be set up locally with a computer through a local USB connection or through an optional Wi-Fi connection. Monitoring and troubleshooting are easy to perform using the faceplate tactile-feedback switches and liquid-crystal display, which shows real-time data and key setpoints. A PC using the Windows® 7 or later operating system can be connected via a USB faceplate connector. IntelliLink® Setup Software is used to view real-time data, manage set points, troubleshoot, and download historical data for reports. The faceplate includes a manual override switch and test points for sensor inputs. An operation counter is provided as a software function. The data logging and perpetual calendar are implemented with non-volatile memory.

The IntelliCap 2000 Automatic Capacitor Control provides a full range of automatic functions:

- Voltage, time, temperature, time-biased voltage, and time-biased temperature control strategies
- Optional var and current control strategies
- Optional neutral-current or voltage sensing to detect blown fuses and stuck switches
- Voltage/temperature override
- Automatic calculation of voltage change caused by capacitor bank switching
- Daily limit on the number of automatic switching operations
- Automatic adjustments for daylight savings time and holidays
- SCADA-override strategy, which allows the master station to issue a command and returns the control to its regular programmed strategy after a user-selected period of time

Line voltage, current, kW, kVAs, kvars, power factor, temperature, and harmonics can all be accessed in real time. The IntelliCap 2000 Automatic Capacitor Control calculates total harmonic distortion as well as the third through 15th harmonics every 15 minutes.

The IntelliCap 2000 Automatic Capacitor Control provides true RMS voltage and current readings. Over the operating temperature range of -40° F (-40° C) to 158° F (70° C), temperature readings are accurate to $\pm 2^\circ$ F ($\pm 1^\circ$ C); current readings are accurate to $\pm 0.15\%$ full scale, with a resolution of 1 ampere RMS; and voltage readings are accurate to $\pm 0.15\%$ full scale, with a resolution of 0.1 Vac. Phase-angle readings are accurate to $\pm 1^\circ$ at 10% of full-scale current, with a resolution of $\frac{1}{8}^\circ$.

The IntelliCap 2000 Automatic Capacitor Control includes extensive data-logging capabilities. The following parameters are logged and can be downloaded as tables or graphs:

- Temperature, voltage, current, power factor, kvar, kW, and neutral current/voltage (if applicable) (Logging intervals can be adjusted from 1 minute to 120 minutes, in 1-minute intervals [15 minutes is default], for two days to 120 days of voltage and temperature data.)
- Up to 10,000 Historic Log entries—includes switching events and the date and time of power cycles
- Daily minimum and maximum voltages, temperatures, current, kW, kvars, power factor, and neutral current/voltage (if applicable), and number of switching cycles in the last month and since installation

The IntelliCap 2000 Automatic Capacitor Control supports both one-way and two-way communication. Distributed Network Protocol (DNP) 3.0 is the standard protocol. A variety of communication devices may be furnished and installed by S&C in the IntelliCap 2000 control enclosure. A variety of customer-furnished communication devices may be accommodated as well. Refer to Table 2 on pages 5 through 7. A pole-mounted single-antenna bracket is available to improve radio performance.

Communication equipment may be factory-installed inside the control enclosure. SpeedNet™ and MDS Adaptive Broadband radios can be accommodated as can fiber-optic transceivers. For further information, contact your nearest S&C Sales Office.

EXCLUSIONS: The IntelliCap 2000 Automatic Capacitor Control does not include a neutral sensing input, communication device, antenna, antenna connections, sensors, or cables.



Conditions of Sale—Continued

S&C may be able to furnish and install in the IntelliCap 2000 control enclosure, or make provision for, a customer-specified communication device *not* listed in Table 2 on pages 5 through 7. S&C will need to evaluate the physical and electrical requirements of the communication device and its performance characteristics, and conduct qualification testing to verify its suitability for the desired application.

Refer to the nearest S&C Sales Office for scheduling information. S&C cannot furnish or install any communication device for which the supplier requires S&C to offer Tier 1 (i.e., “help desk”) support.

SPECIFICATION DEVIATIONS: Refer to Table 2 on pages 5 through 7.

SPECIAL WARRANTY PROVISIONS: The standard warranty contained in the seller’s standard conditions of sale, as set forth in Price Sheet 150, applies to IntelliCap 2000 Automatic Capacitor Controls, except the first paragraph of said warranty is replaced by the following:

General: The seller warrants to the immediate purchaser or end user for a period of 10 years from the date of shipment that the equipment delivered will be of the kind and quality specified in the contract description and will be free of defects of workmanship and material. Should any failure to conform to this warranty appear under proper and normal use within 10 years after the date of shipment, the seller agrees, upon prompt notification thereof and confirmation that the equipment has been stored, installed, operated, inspected, and maintained in accordance with recommendations of the seller and standard industry practice, to correct the nonconformity either by repairing any damaged or defective parts of the equipment or (at the seller’s option) by shipment

of necessary replacement parts. The seller’s warranty does not apply to any equipment that has been disassembled, repaired, or altered by anyone other than the seller. This limited warranty is granted only to the immediate purchaser or, if the equipment is purchased by a third party for installation in third-party equipment, the end user of the equipment. The seller’s duty to perform under any warranty may be delayed, at the seller’s sole option, until the seller has been paid in full for all goods purchased by the immediate purchaser. No such delay shall extend the warranty period.

Replacement parts provided by the seller or repairs performed by the seller under the warranty for the original equipment will be covered by the above special warranty provision for its duration. Replacement parts purchased separately will be covered by the above special warranty provision.

WARRANTY QUALIFICATIONS: Warranty of IntelliCap 2000 Automatic Capacitor Controls is contingent upon the installation, configuration, and use of the control or software in accordance with S&C’s applicable instruction sheets. This warranty does not apply to major components not of S&C manufacture, such as batteries, communication devices, and remote terminal units. However, S&C will assign to the immediate purchaser or end user all manufacturers’ warranties that apply to such major components.

END USER LICENSE AGREEMENT: The end user is granted a nontransferable, non-sublicensable, nonexclusive license to use the IntelliLink® Setup Software and/or other software furnished with IntelliCap 2000 Automatic Capacitor Controls only upon acceptance of all the terms and conditions of the seller’s end user license agreement set forth in Price Sheet 155.

How to Order

Complete the following steps to build an IntelliCap 2000 Automatic Capacitor Control catalog number. Included with the steps are fill-in boxes to help keep track of the various components of the final catalog number.

Note: Pay strict attention to the various table footnotes, which identify constraints and considerations regarding the selection of the various options.

STEP 1. Choose the capacitor control catalog number from Table 1 on page 4.

Catalog Number:

STEP 2. (Optional) Choose the suffixes for any desired options from Table 2 on pages 5 through 7.

Suffix:

STEP 3. Choose the mounting type suffix from Table 4 on page 9.

Suffix:

Note: If the mounting type is not selected, an M-option from Step 2 must be specified.

STEP 4. (Optional) Choose the catalog numbers for any accessories from Table 5 on page 10.

Catalog Number:

STEP 5. (Optional) Choose the catalog number for the desired power cables from Table 6 on page 10.

Catalog Number:

STEP 6. (Optional) Choose the appropriate catalog number for sensor cables from Table 7 on page 10 and Tables 8 and 9 on page 11.

Catalog Number:

STEP 7. (Optional) Choose the catalog number for the applicable meter box from Table 10 on page 11.

Catalog Number:

Example: The catalog number for an IntelliCap 2000 control with a USB connector for local communication and a padlockable Lexan® NEMA 3R enclosure; control strategies that include time, temperature, and voltage; single-phase voltage sensing provided by a customer-furnished voltage transformer; a pole-mounting bracket; and a GPS module with a door-mounted N-Type 900-MHz 5-dB GPS antenna is 240120-JB1A4T2S1.

Table 1. IntelliCap 2000 Automatic Capacitor Controls

Device	Control-Source Voltage	Output Relay Contacts	Control Strategies	Catalog Number	Page Reference for Dimensional Information	Net Wt. Lbs. (Kg.)
IntelliCap 2000 control with USB connector for local communication and padlockable Lexan NEMA 3R enclosure. Does not include neutral sensing input communication device, antenna, or antenna connections. Mounting type must be specified from Table 4 on page 9	100 to 135 Vac, 50 or 60 Hz	1 open, 1 closed; pulsed or latched; rated 20 A at 250 Vac, 1 HP at 120/250 Vac single phase, 3 digital inputs	Standard: time, temperature, and voltage, with single-phase voltage sensing provided by a customer-furnished voltage transformer	240120	9	8¼ (3.74)
			Standard plus var and current with single-phase current sensing provided by a customer-furnished or S&C-furnished CS or CSV Line Post Sensor	240160●■	10	8¼ (3.74)
			Standard plus var and current with single-phase current sensing provided by a customer-furnished 0- to 1-A or 0- to 5-A current transformer	240164▲	10	8¼ (3.74)

● Refer to Specification Bulletin 1061-31 for ordering information on CS and CSV Line Post Sensors. Cables are required. Refer to Table 7 on page 10 and Tables 8 and 9 on page 11 for ordering information.

■ Customer-furnished sensors must be high-impedance, low output-energy sensors, to avoid damaging the sensor input and voiding the warranty. A burdened current transformer of any kind cannot be used.

▲ Customer to provide shorting block.

Table 2. Options

Item	Suffix to Be Added to IntelliCap 2000 Catalog Number	
Wi-Fi module with antenna, for wireless setup (Not available outside the United States and Canada. Contact S&C for options in other countries)	-A3	
GPS module (requires GPS antenna. See Table 5 on page 9. Antenna is included with Wi-Fi module with antenna, suffix "-A3")	-A4	
Wi-Fi/GPS module with antenna, for wireless setup (Not available outside the United States and Canada. Contact S&C for options in other countries)	-A5	
Terminal block cover	-C	
Door switch, provides "Cabinet Door Open" indication when connected to User Status Input	-D	
Neutral alarm LED indicator	-E	
Control for 50-Hz system frequency	-H	
Voltage Input Sensing		
Voltage Input, 0- to 10-V from S&C CSV Line Post Current/Voltage Sensor	-K1	
Reversed colors for OPEN/CLOSE indicators (green = closed, red = open)	-L1	
Foreign language labels, front panel, and screens ^①	Spanish	-L51
	Portuguese	-L52●
	French	-L53
	Chinese	-L54
	Arabic	-L55
Connectors (multiple types may be specified; standard is terminal strip; option is for bracket mounting, pole, or wall)		
Neutral sensor cable entry, opening blocked with shipping plug	-M0	
Five-pin mil spec for bracket-mounted control	-M1■	
Seven-pin mil spec for bracket-mounted control	-M3■	
Three-pin mil spec for phase current input	-M5■▲	
Three-pin mil spec for neutral current/voltage input	-M7■	
Five-pin mil spec for user definable digital inputs	-M11■	
Neutral Input Sensing		
Current input, 0-10 V ^②	-N1◆	
Potential transformer voltage sensor input, 0-144 Vac	-N2	
S&C Voltage Sensor Input, 0-144 Vac	-N3	
Lindsey Voltage Sensor Input, 0-5 Vac	-N4	
Fisher-Pierce AT 929 Sensor Input	-N5	
Communication Protocol		
DNP 3.0	-P0	

① Labels will add four weeks to lead time. Spanish front panels are available. Contact the nearest S&C Sales Office for French, Chinese, and Arabic front panel availability, and screen availability.

② Neutral current sensors should only be applied on double-bushing capacitors. Single-bushing capacitors have a ground connection internally connected to the case and are grounded through the mounting rack; there is no common point where the three phase currents can be sensed.

● Portuguese labels and front panels are available at standard lead times.

■ Multiple connectors may be specified. See Table 3 on page 8.

▲ May also be used with a four-jaw socket mount control.

◆ Refer to Specification Bulletin 1062-31 for ordering information on neutral current sensors.

TABLE CONTINUED ►

Table 2. Options—Continued

Item	Suffix to Be Added to IntelliCap 2000 Catalog Number
Communication Device and Mounting (furnished by S&C, requires suffix “-R98”)	
MDS TransNET 900 Transceiver	-R18
Multi-Mode Dymec 5843HRT Fiber-Optic Modem	-R45
SpeedNet™ Radio	-R80
Telemetric DNP-RTMII-FLX for FlexNet system	-R148
MDS SD9 Remote Radio	●
SpeedNet™ ME Mesh End-Point Radio	-R240
SpeedNet™ Cell Edge Gateway 4G LTE cellular modem for AT&T Cellular Network (With embedded AT&T SIM)	-R320
SpeedNet™ Cell Edge Gateway 4G LTE cellular modem with removable SIM card for USA and Canada①	-R352

● Specify the appropriate catalog number suffix based on the frequency band range and application for the radio from the following table. For example, for a 928- to 960-MHz MDS SD9 Radio for Ethernet and serial application, specify catalog number suffix “-R216CL.”

① See Specification Bulletin 1076-31 for SpeedNet Cell Edge Gateway antenna options.

TABLE CONTINUED ►

NOTE: The power supply is capable of providing 12-W average continuous power to the radio. Peak transmit is limited to 20 W for a maximum of 250 ms.

Frequency Band Range, MHz	Application	Suffix to be Added to Catalog Number
820 to 870	Serial	-R216AK
928 to 960		-R216CK
928 to 960, 50-kHz channel		-R216DK
880 to 915		-R216EK
880 to 915, 50-kHz channel		-R216FK
850 to 860 / 926 to 936, transmit low		-R216GK
850 to 860 / 926 to 936, transmit high		-R216HK
820 to 870		Ethernet and Serial
928 to 960	-R216CL	
928 to 960, 50-kHz channel	-R216DL	
880 to 915	-R216EL	
880 to 915, 50-kHz channel	-R216FL	
850 to 860 / 926 to 936, transmit low	-R216GL	
850 to 860 / 926 to 936, transmit high	-R216HL	
820 to 870	9710 Emulation	
928 to 960		-R216CM
928 to 960, 50-kHz channel		-R216DM
880 to 915		-R216EM
880 to 915, 50-kHz channel		-R216FM
850 to 860 / 926 to 936, transmit low		-R216GM
850 to 860 / 926 to 936, transmit high		-R216HM

Table 2. Options—Continued

Item	Suffix to Be Added to IntelliCap 2000 Catalog Number
Communication Device Ready for (communication device furnished by customer)	
MDS 9810 Radio	-R02
MDS TransNet 900 Radio	-R07
Silver Spring Networks eBridge Radio	-R125
Telemetric DNP-RTMII-FLX for FlexNet system	-R147
MDS Mercury 3650 HGR3 Remote Radio	-R151
MDS SD9 Remote Radio	-R188
SpeedNet™ ME Mesh End-Point Radio	-R241
Cradlepoint COR IBR600 Series integrated broadband routers	-R266
Ready for Tantalus DA Bridge Modem	-R273
Sierra Wireless RV50 LTE cellular modem	-R316
GE MDS Orbit ECR wireless router with single WAN radio	-R328
Cisco IR807 Integrated Services Router with 4G LTE cellular modem	-R330
Installation of Communication Device	
Furnished by S&C	-R98
Furnished by customer	-R99
Antenna Connections	
N-Type connector, door top mounted (for mounting whip antenna)	-S1
N-Type connector, bottom mounted (for remote antenna installation)	-S2
PolyPhaser® Surge Suppressor, N-type connector, bottom mounted (for remote antenna installation)	-S3
NMO-type mounting for Antenex Phantom Antenna, door top	-S4
Dual-band cellular antenna connection	-S5
PolyPhaser® Surge Suppressor, N-type connector, 800-2300 MHz, for dual band cellular antenna	-S6
Antenna	
900-MHz 5-dB gain antenna, door mounted	-T2
Antenex Spread-Spectrum Antenna	-T3
Antenex Phantom Antenna, model TRAB821/18503P, dual band (821-896 and 1850-1990 MHz), 3 dB-MEG	-T4
Dual Band LoPro® Cellular Antenna (824-896 and 1850-1990 MHz), 3 dBi	-T7
Permanent Phantom Antenna 3G-4G multi-band (698-960, 1700-2700 MHz) N-type female, black	-T18

Note: More radios will be added to the list in the future. For other radios not yet in the table, contact S&C.

Exclusions: S&C may be able to furnish and install in the IntelliCap 2000 control, or make provision for, a customer-specified communication device not listed in Table 2 on pages 6 and 7. S&C will need to evaluate the

physical and electrical requirements of the communication device and its performance characteristics and conduct qualification testing to verify its suitability for the desired application. S&C cannot furnish or install any communication device for which the supplier requires S&C to offer Tier I (i.e., “help desk”) support.

Table 3. Connector Combinations

Valid Combinations Numbers in () = Connector Positions	Mounting Restrictions	Catalog Restrictions
M1 (5)	JB1 and JB2 only	None
M3 (7)	JB1 and JB2 only	None
M5 (3)	Not allowed with J60, J61, J62, J63, J64, J69, and J70	Not allowed with 240120
M7 (3)	Not allowed with J60, J68, and J70	None
M11 (5)	None	None
M1 (5), M5 (3)	JB1 and JB2 only	Not allowed with 240120
M1 (5), M7 (3)	JB1 and JB2 only	None
M1 (5), M11 (5)	JB1 and JB2 only	None
M1 (5), M5 (3), M7 (3)	JB1 and JB2 only	Not allowed with 240120
M5 (3), M7 (3)	Not allowed with J60, J61, J62, J63, J64, J68, J69, and J70	Not allowed with 240120
M3 (7), M11 (5)	JB1 and JB2 only	None
M5 (3), M11 (5)	Not allowed with J60, J61, J62, J63, J64, J69, and J70	Not allowed with 240120
M7 (3), M11 (5)	Not allowed with J60, J68, and J70	None
M5 (3), M7 (3), M11 (5)	Not allowed with J60, J61, J62, J63, J64, J68, J69, and J70	Not allowed with 240120
K1 (3)	None	None
K1 (3), M1 (5)	JB1 and JB2 only	None
K1 (3), M3 (7)	JB1 and JB2 only	None
K1 (3), M5 (3)	Not allowed with J60, J61, J62, J63, J64, J69, and J70	Not allowed with 240120
K1 (3), M7 (3)	Not allowed with J60, J68, and J70	None
K1, M11 (5)	None	None
K1, M1 (5), M5 (3)	JB1 and JB2 only	Not allowed with 240120
K1, M1 (5), M7 (3)	JB1 and JB2 only	None
K1, M1 (5), M11 (5)	JB1 and JB2 only	None
K1, M5 (3), M7 (3)	Not allowed with J60, J61, J62, J63, J64, J68, J69, and J70	Not allowed with 240120
K1, M3 (7), M11 (5)	JB1 and JB2 only	None
K1, M5 (3), M11 (5)	Not allowed with J60, J61, J62, J63, J64, J69, and J70	Not allowed with 240120
K1, M7 (3), M11 (5)	Not allowed with J60, J68, and J70	None

Table 4. Mounting Type—Must Be Specified

Item	Suffix to Be Added to IntelliCap 2000 Catalog Number
Four-jaw electric meter base ^{①②}	-J40
Four-jaw electric meter base ^{①②}	-J41
Four-jaw electric meter base ^{①②}	-J42
Six-jaw electric meter base ^{①③④}	-J60
Six-jaw electric meter base ^{①③}	-J61
Six-jaw electric meter base ^{①③}	-J62
Six-jaw electric meter base ^{①③}	-J63
Six-jaw electric meter base ^{①②}	-J64
Six-jaw electric meter base ^{①②}	-J65
Pole-mounting bracket ^⑤	-JB1
Wall-mounting bracket ^{①⑤}	-JB2
Demonstration stand	-JB9
Wall-mounting bracket with 3-foot (91-cm) cable, standard wiring ^②	-J67
Six-jaw electric meter base ^①	-J68
Mounting: Wall-mounting bracket with 3-foot (91-cm) cable. standard wiring with var for current transformer ^⑥	-J69
Mounting: Wall-mounting bracket with 3-foot (91-cm) cable. standard wiring with var plus neutral, for current transformer ^⑥	-J70

① See page 12 for electric meter base wiring configuration.

② Not available on IntelliCap 2000 control catalog numbers 240160 and 240164.

③ Not available on IntelliCap 2000 control catalog number 240120.

④ Only available on IntelliCap 2000 control catalog number 240160 with neutral input sensing (options “-N1,” “-N2,” “-N3,” or “-N4”).

⑤ See page 13 for connector configurations.

⑥ Only available on IntelliCap 2000 control catalog number 240164.

Table 5. Accessories

Item		Catalog Number	
Pole-mount antenna kit for GPS, includes 25-foot (7.62 meter) cable, mounting bracket, and antenna. Custom cable length can be quoted. Requires surge suppressor catalog number 005-001471-01		903-002344-01	
Description		Model	Catalog Number
Remote antenna kit, includes omnidirectional antenna, mounting bracket	With 30-foot (9.1-m) coaxial cable with connectors on both ends	MA-30-PM	903-002132-02
	With 50-foot (15.2-m) coaxial cable with connectors on both ends	MA-50-PM	903-002132-03
WanGate Pole-Mount Bracket, includes 40-foot (12.2-m) communications cable, order with catalog number suffix "-R06"		—	903-002174-01

Table 6. S&C Power Cables—Control to Junction Box

For Use with IntelliCap 2000 Catalog Number	Length, Feet (Centimeters)	End One Connector	End Two Connector	Catalog Number
240120	30 (914)	5-pin	5-pin	007-001236-02
	35 (1067)	5-pin	None	007-000262-04
	35 (1067)	5-pin	5-pin	007-001236-01
	40 (1219)	5-pin	None	007-000262-01
	40 (1219)	5-pin	5-pin	007-001236-03
	50 (1524)	5-pin	None	007-000262-03

Table 7. S&C Sensor Cables—Control to Junction Box

For Use with IntelliCap 2000 Catalog Numbers	Length, Feet (Centimeters)	End One Connector	End Two Connector	Catalog Number
240120 and 24016	35 (1067)	7-pin	None	007-001138-01
	35 (1067)	7-pin	7-pin	007-001139-01
	40 (1219)	7-pin	None	007-001138-02

Table 8. S&C Sensor Cables—Junction Box to Current Sensor

For Use with IntelliCap 2000 Catalog Number	Length, Feet (Centimeters)	End One Connector	End Two Connector	Catalog Number
240160	20 (610)	None	None	007-000973-04
	20 (610)		2-pin	007-000767-03
	30 (914)		2-pin	007-000767-04
	35 (1067)		None	007-000973-03
	35 (1067)		2-pin	007-000767-05
	40 (1219)		None	007-000973-01
	40 (1219)		2-pin	007-000767-01
	50 (1524)		None	007-000973-02
	50 (1524)		2-pin	007-000767-02

Table 9. S&C Sensor Cables—Control to Current Sensor

For Use with IntelliCap 2000 Catalog Number	Length, Feet (Centimeters)	End One Connector	End Two Connector	Catalog Number
240160	20 (610)	3-pin	2-pin	007-000261-04
	35 (1067)			007-000261-05
	40 (1219)			007-000261-01
	50 (1524)			007-000261-03
	60 (1829)			007-000261-02
	65 (1981)			007-000261-07

Table 10. Meter Base—Includes Mounting Bracket and Meter Ring

For Use with IntelliCap 2000 Catalog Number	Type	Catalog Number
240120	4-jaw	904-000005-00
240120, 240160, 240164	6-jaw	904-000005-01

Electric Meter Base Wiring Configurations

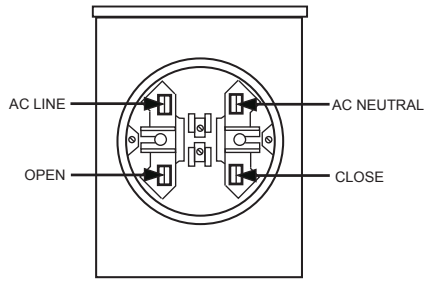

Four-Jaw Electric Meter Base, Catalog Number Suffix “-J40”
 (Catalog number suffix “-J41” reverses ac line and ac neutral). (Catalog number suffix “-J42” reverses open and close)

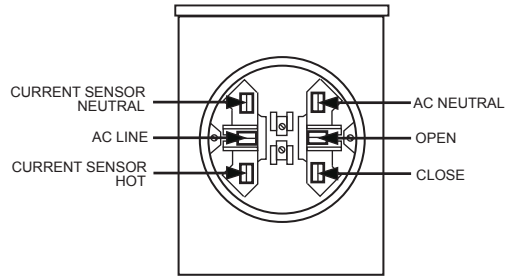

Six-Jaw Electric Meter Base, Catalog Number Suffix “-J63”

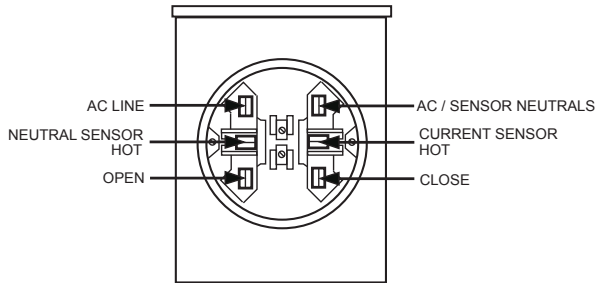

Six-Jaw Electric Meter Base, Catalog Number Suffix “-J60”

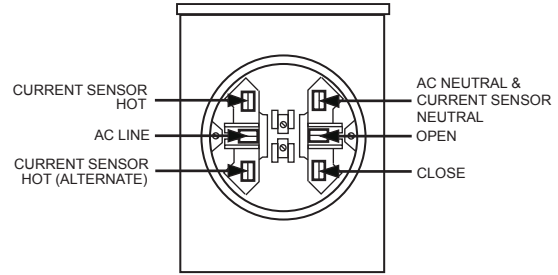

Six-Jaw Electric Meter Base, Catalog Number Suffix “-J64”

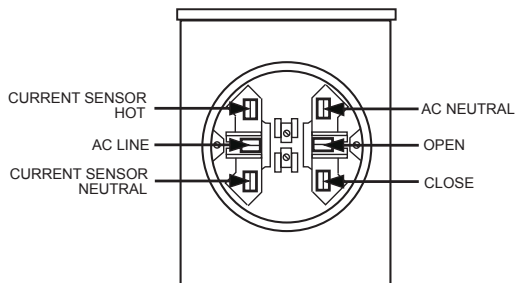

Six-Jaw Electric Meter Base, Catalog Number Suffix “-J61”

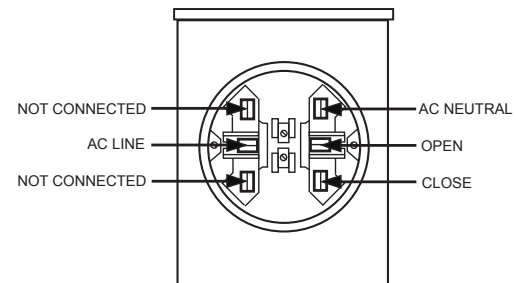

Six-Jaw Electric Meter Base, Catalog Number Suffix “-J65”

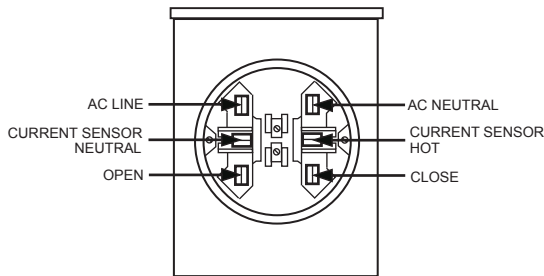

Six-Jaw Electric Meter Base, Catalog Number Suffix “-J62”

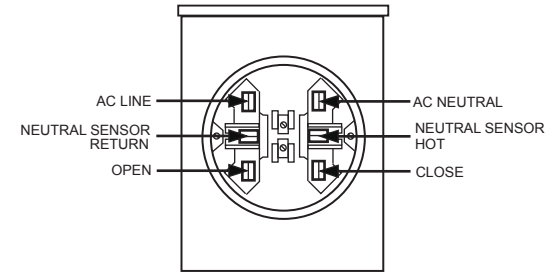

Six-Jaw Electric Meter Base, Catalog Number Suffix “-J68”

Connector Configurations—For Wall or Pole-Mounting Bracket

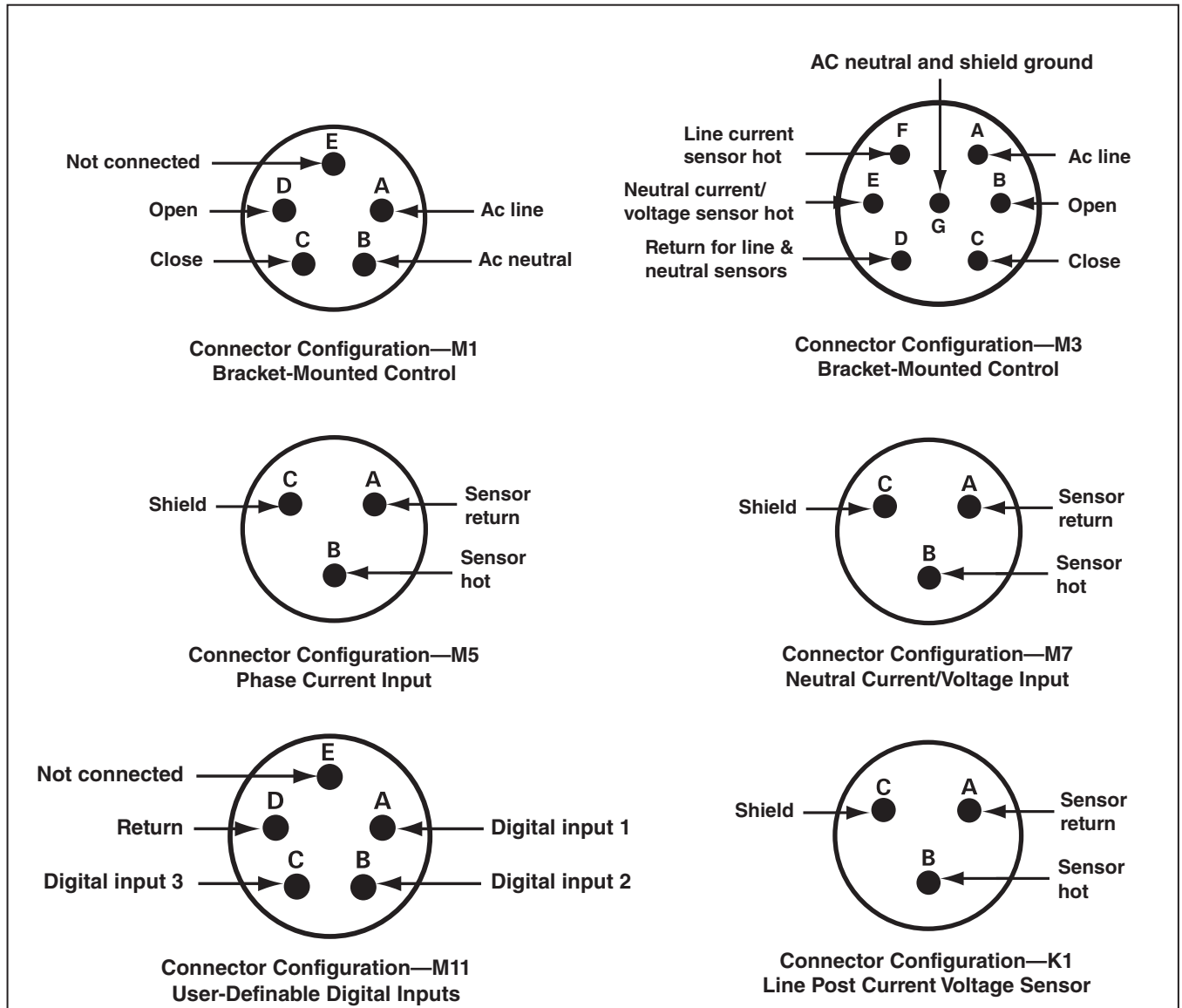

Terminal Strip Configuration—For Wall or Pole Mounting Bracket

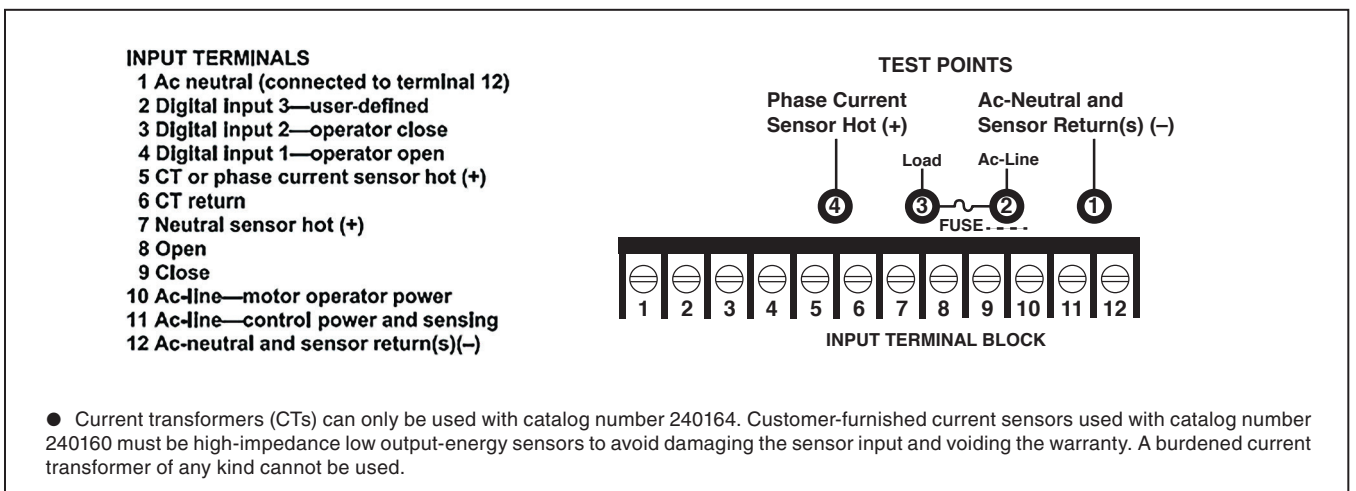

Typical Installation of IntelliCap 2000 Automatic Capacitor Control

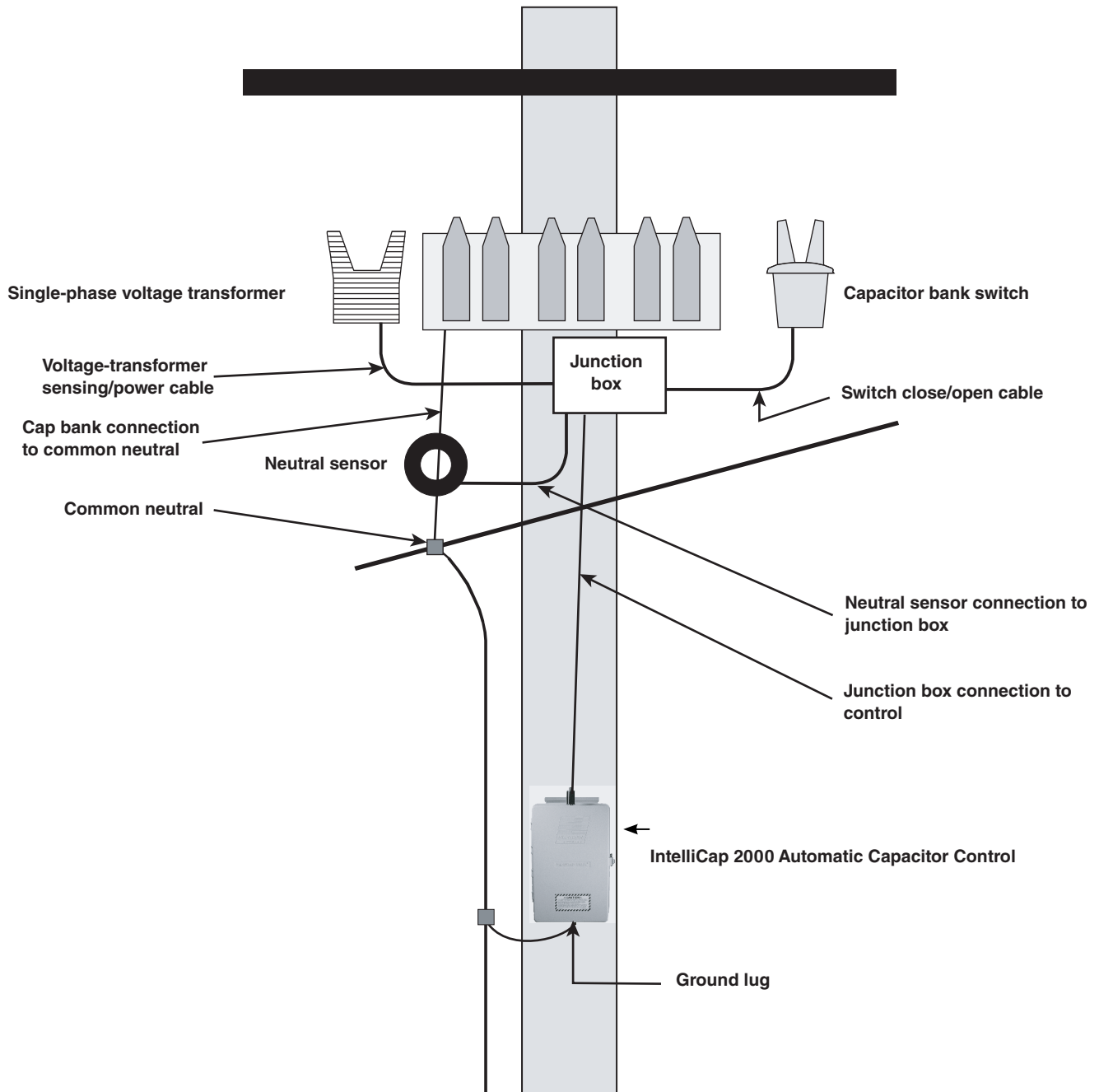

NOTE: Neutral sensor is optional and includes the cable.

Typical Installation of IntelliCap 2000 Automatic Capacitor Control

Catalog Numbers 240160 and 240164

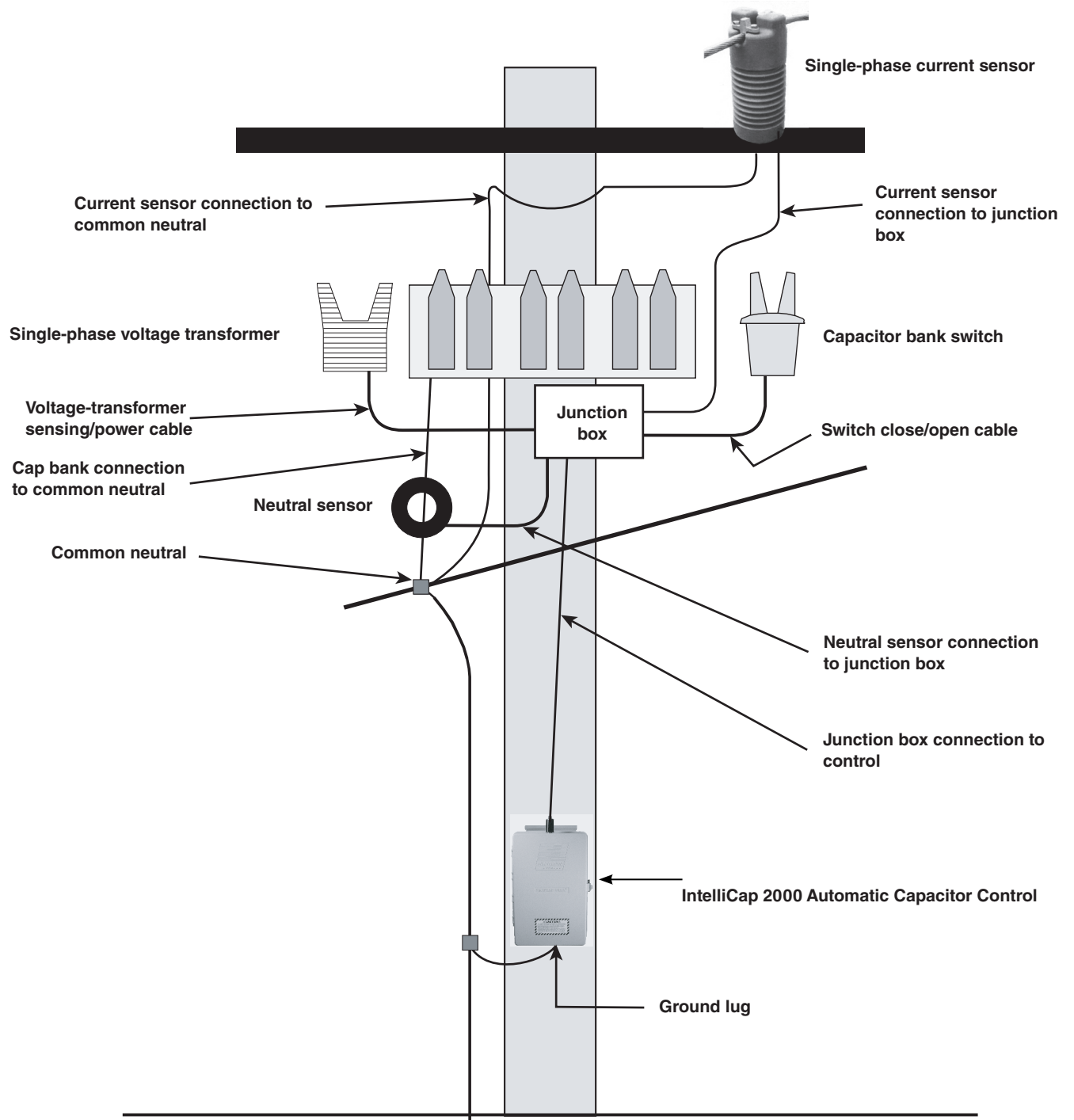

NOTE: Neutral sensor is optional and includes the cable.

IntelliCap® 2000 Automatic Capacitor Control

IntelliCap 2000 Automatic Capacitor Control Meter-Base Mounted

Dimensions in inches (millimeters)

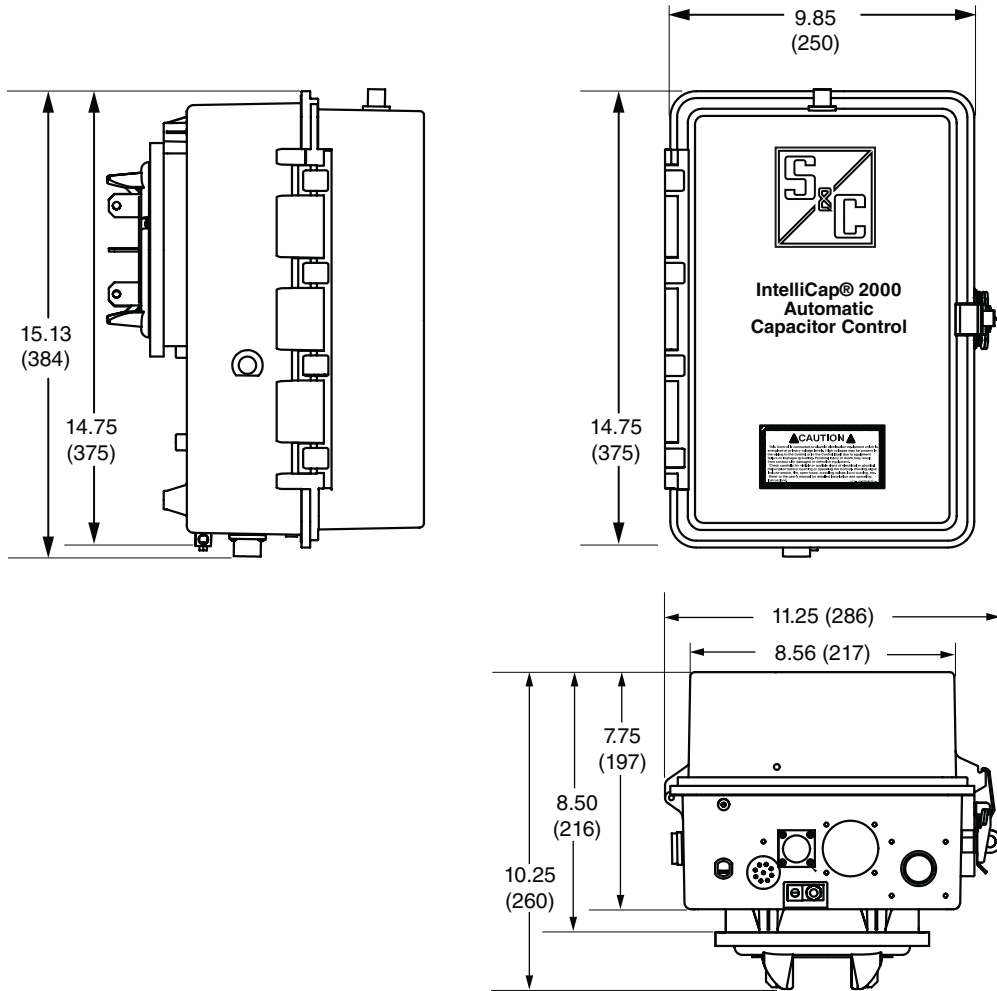

IntelliCap 2000 Automatic Capacitor Control
Pole-Mounted

Dimensions in inches (millimeters)

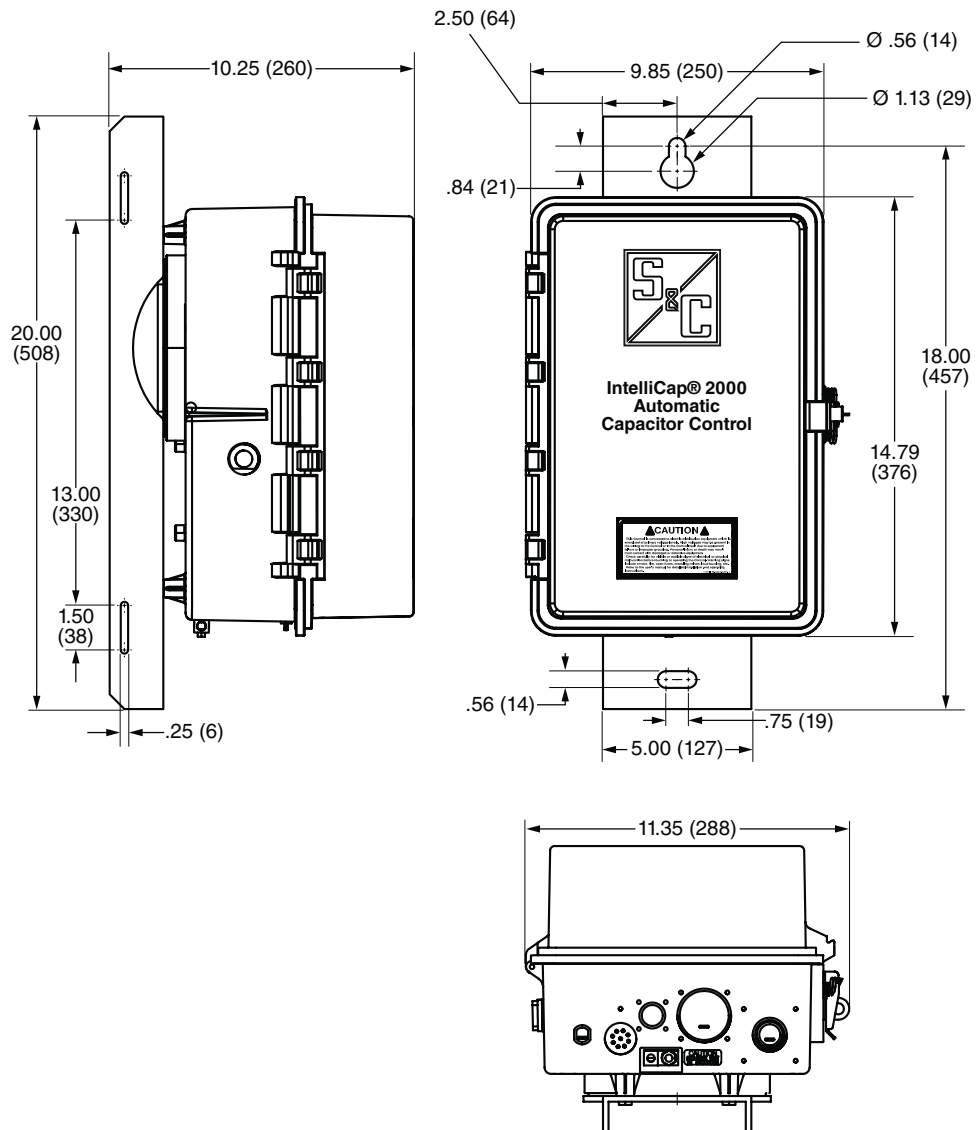

IntelliCap® 2000 Automatic Capacitor Control

IntelliCap 2000 Automatic Capacitor Control Wall-Mounted

Dimensions in inches (millimeters)

